



US007878396B2

(12) **United States Patent**
Wishnatzki et al.

(10) **Patent No.:** **US 7,878,396 B2**

(45) **Date of Patent:** **Feb. 1, 2011**

(54) **SYSTEM AND METHOD FOR TRACKING ORIGINS OF PRODUCE**

2005/0086132 A1 4/2005 Kanitz et al.
2006/0111845 A1 5/2006 Forbis et al.
2007/0293980 A1 12/2007 Gudjonsson et al.

(75) Inventors: **Gary Wishnatzki**, Tampa, FL (US);
Minor Bolanos, Tampa, FL (US)

FOREIGN PATENT DOCUMENTS

(73) Assignee: **Virtualone, LLC**, Plant City, FL (US)

JP 2002-297625 10/2002
KR 10-1999-0019378 3/1999
KR 1999-019378 * 3/1999
KR 10-2004-0110912 12/2004
KR 10-2006-0131500 12/2006

(*) Notice: Subject to any disclaimer, the term of this patent is extended or adjusted under 35 U.S.C. 154(b) by 1 day.

* cited by examiner

(21) Appl. No.: **12/060,734**

Primary Examiner—Thien M Le

(22) Filed: **Apr. 1, 2008**

(74) *Attorney, Agent, or Firm*—Larson & Larson, P.A.; Frank Liebenow; Justin Miller

(65) **Prior Publication Data**

US 2009/0242631 A1 Oct. 1, 2009

(57) **ABSTRACT**

(51) **Int. Cl.**
G06F 19/00 (2006.01)

An application for a method for tracking produce delivered to a consumer includes providing a field box and a plurality of containers for holding produce, the containers fitting within the field box. A master label that has a master label barcode and a plurality of sub-labels is provided. The master label barcode has a sequence of digital values; the sequence of digital values uniquely distinguishes each master label. Each sub label has a sub-label identifier related to or equivalent to the master label bar-code. The master label is affixed to the field box and each of the sub-labels from the master label is affixed to one of the containers. The containers are then filled with produce and placed into the field box. The master label barcode is captured with a scanner and either now or at a later time, the captured master label barcode and an identification of the origin of the produce are transferred to a server where they are storing in a barcode tracking database.

(52) **U.S. Cl.** **235/385**; 235/463

(58) **Field of Classification Search** 235/385,
235/463

See application file for complete search history.

(56) **References Cited**

U.S. PATENT DOCUMENTS

5,166,500 A * 11/1992 Yoon et al. 235/462.07
5,478,990 A 12/1995 Montanari et al.
5,783,810 A * 7/1998 Kelly, Jr. 235/385
6,945,459 B2 9/2005 Flanagan
6,969,003 B2 11/2005 Havens et al.
2003/0226787 A1 12/2003 Buisman et al.
2005/0075900 A1 * 4/2005 Arguimbau, III 705/1

20 Claims, 9 Drawing Sheets

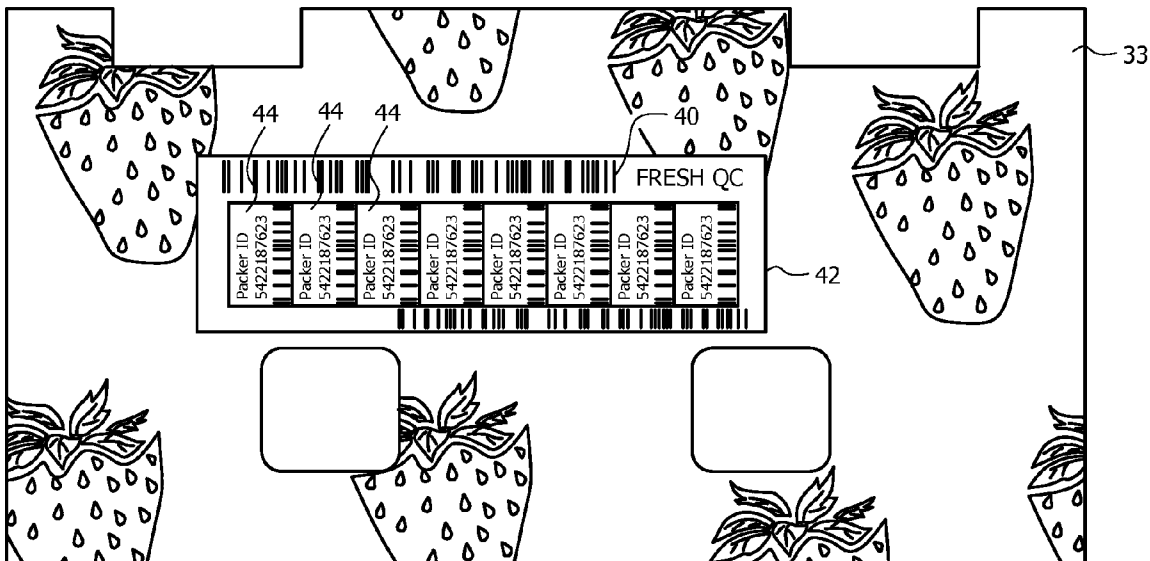

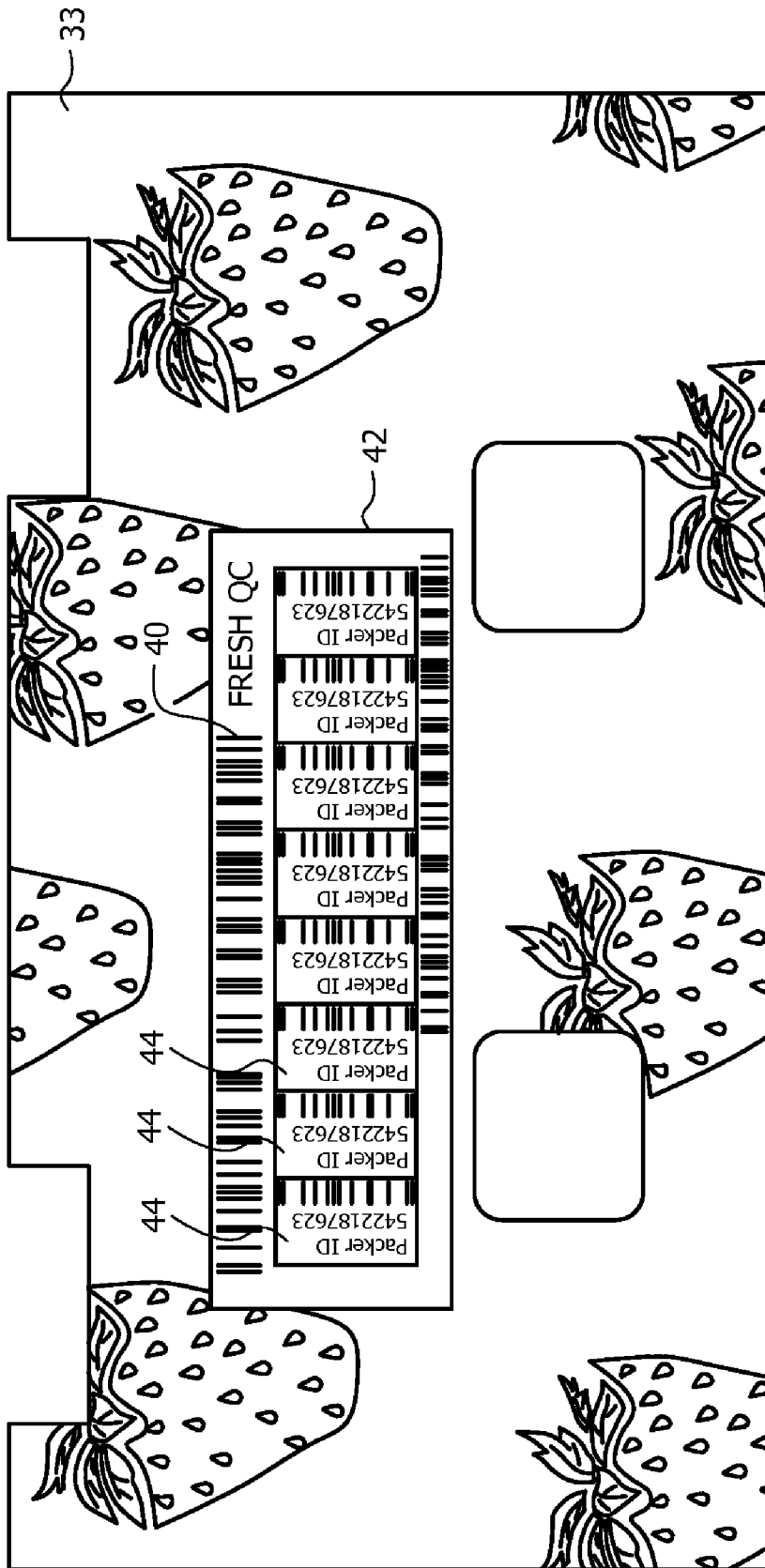

FIG. 1

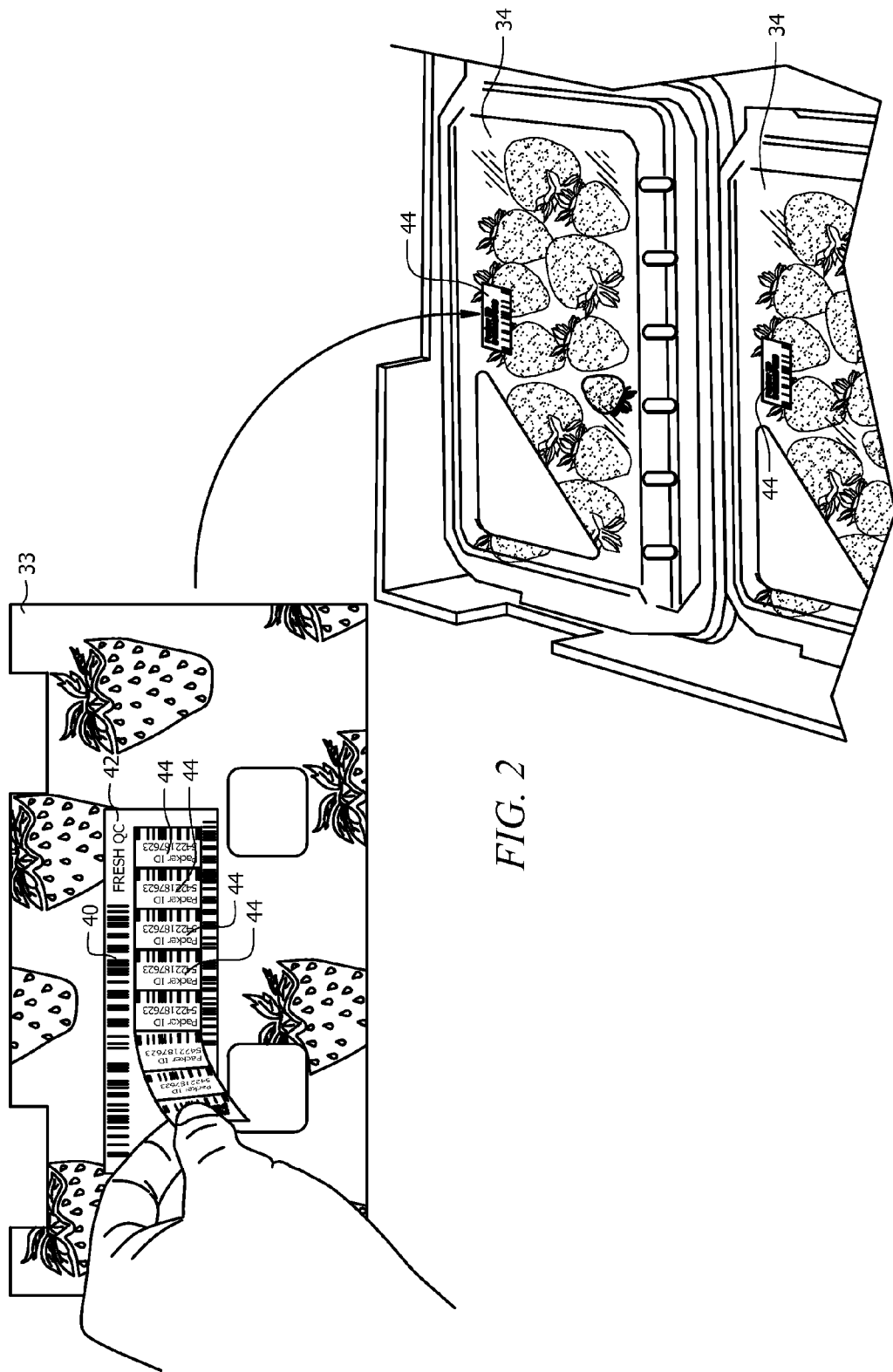

FIG. 2

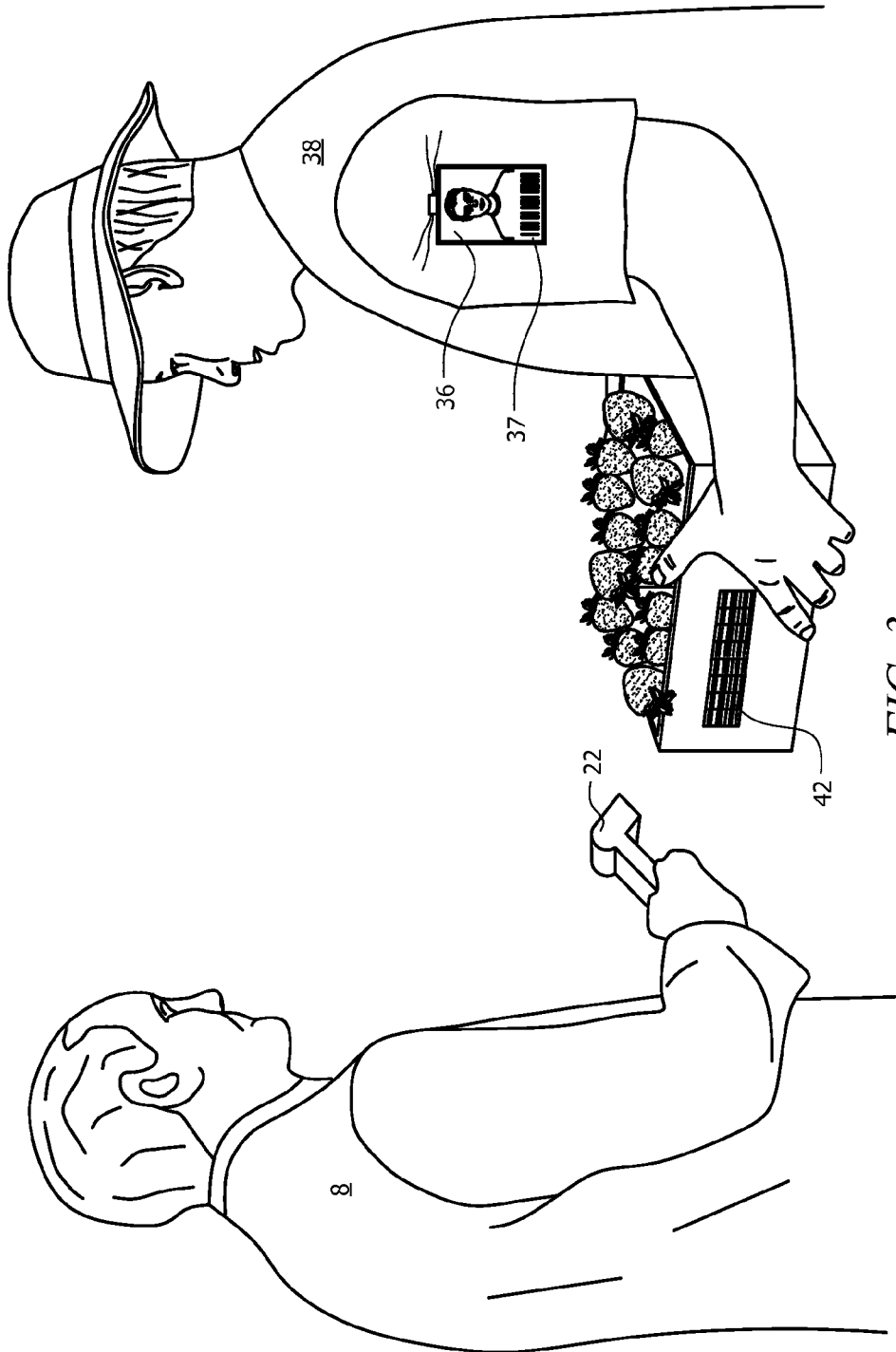

FIG. 3

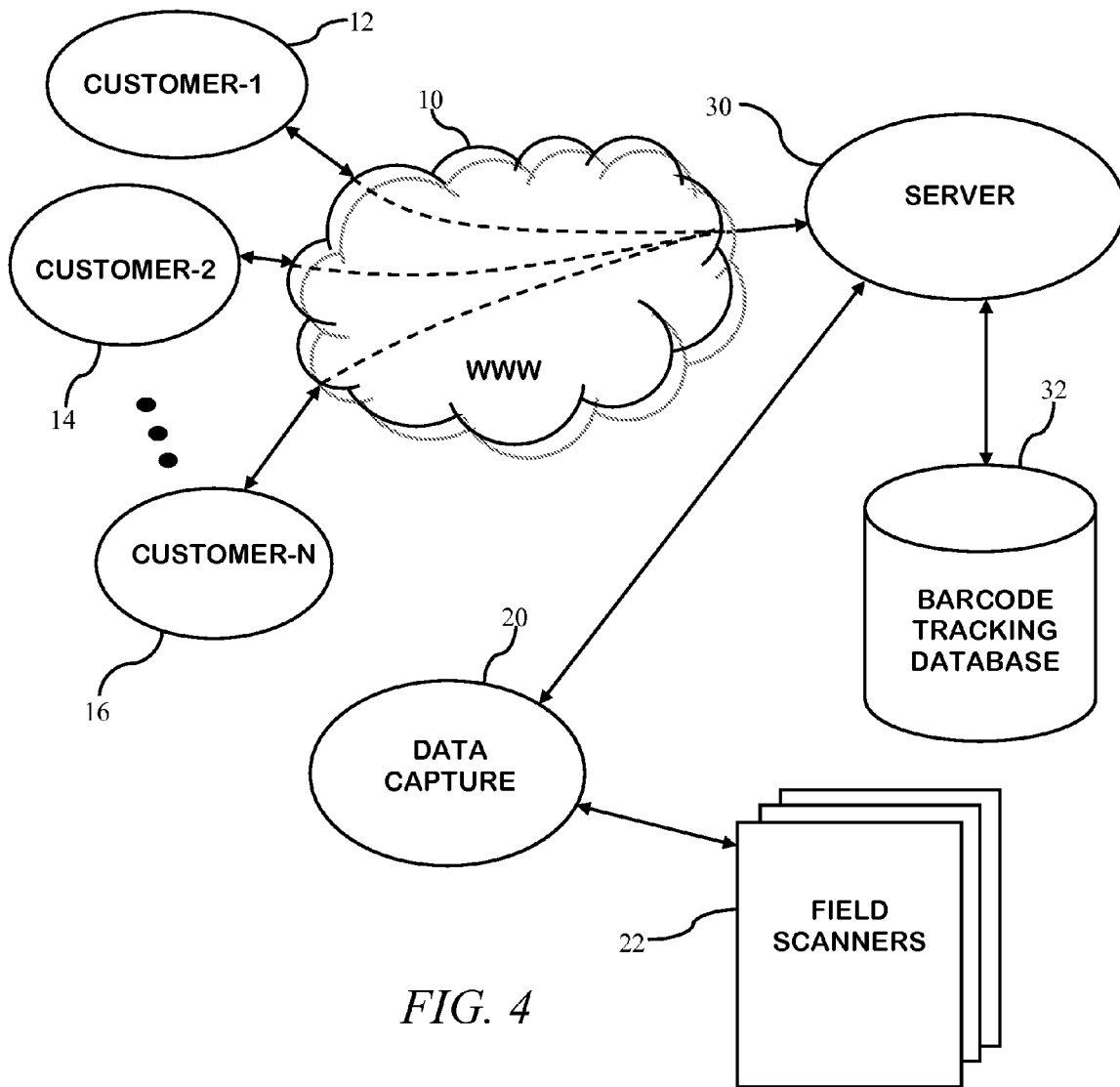

FIG. 4

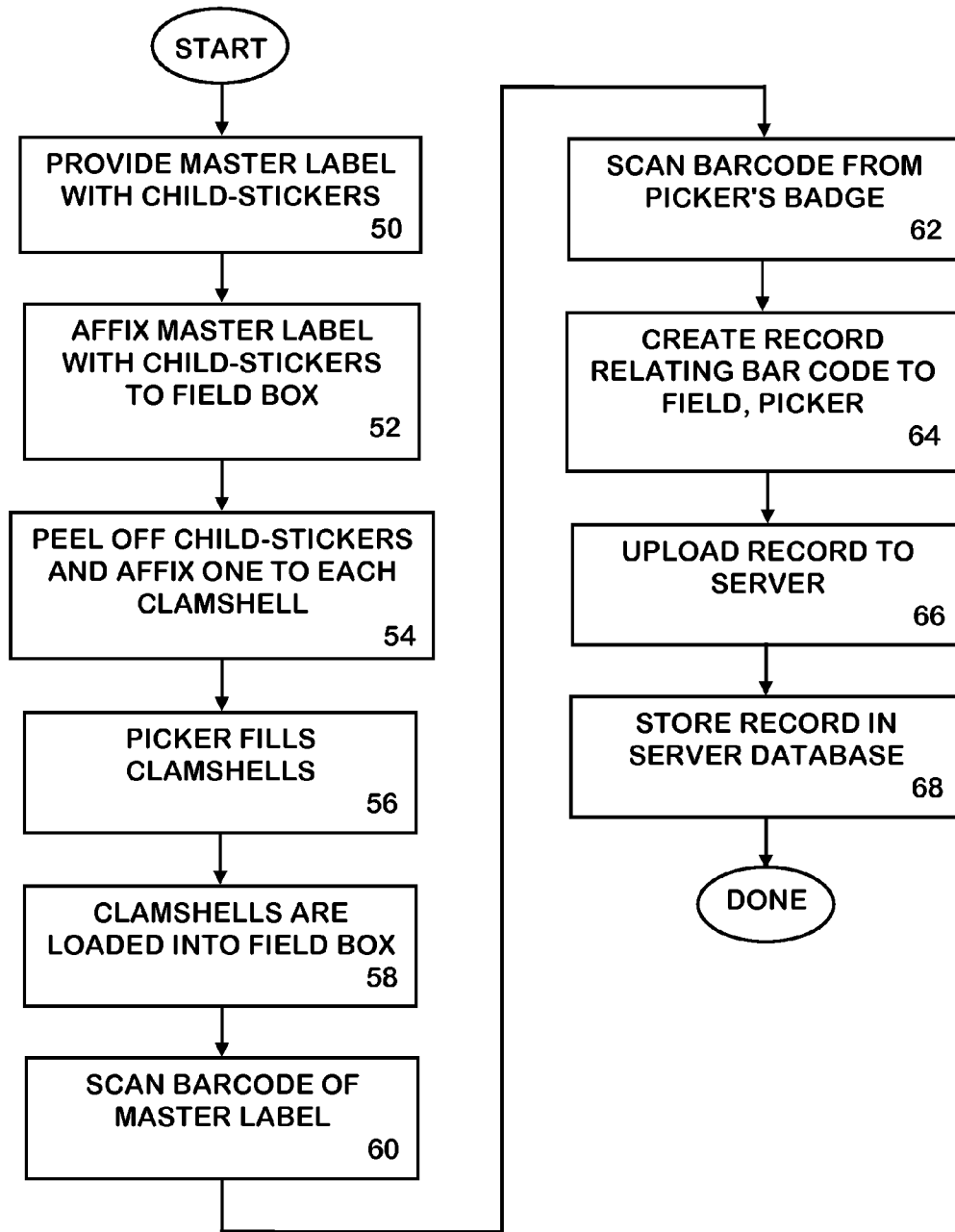

FIG. 5

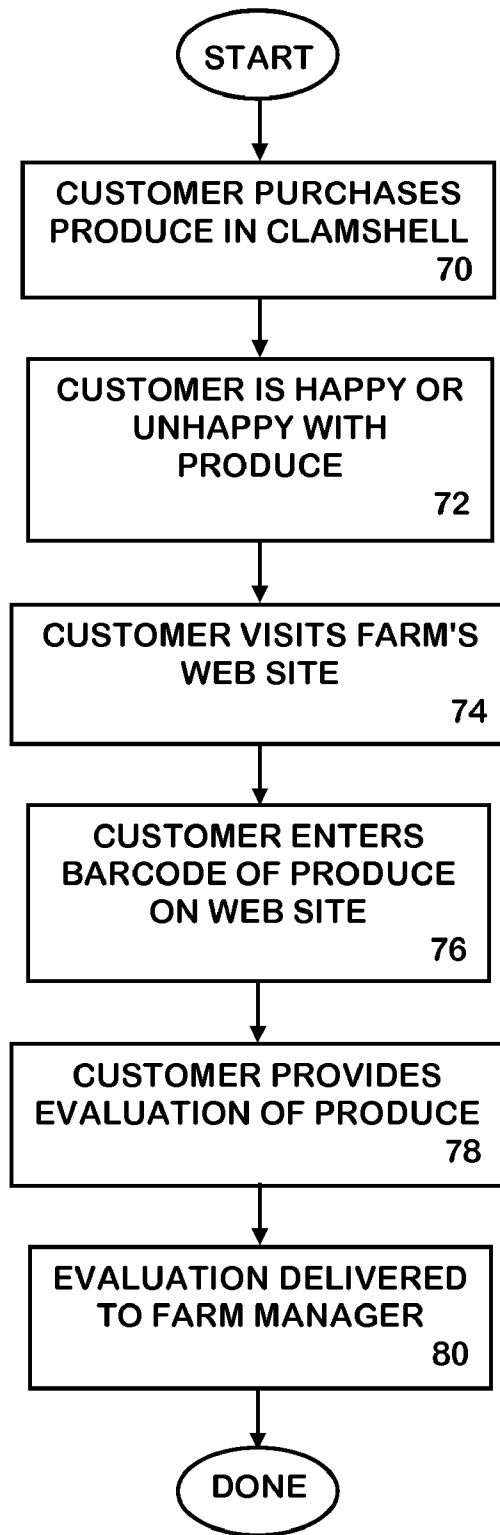

FIG. 6

90

FIRST NAME:

LAST NAME:

EMAIL ADDRESS:

PHONE NUMBER:

BARCODE NUMBER:

REPEAT BARCODE:

PLACE OF PURCHASE:

COMMENTS:

PRODUCT ISSUE:

- NOT RIPE
- SPOILED/MOLD
- QUANTITY LOW
- TASTE BAD

92

FIG. 7

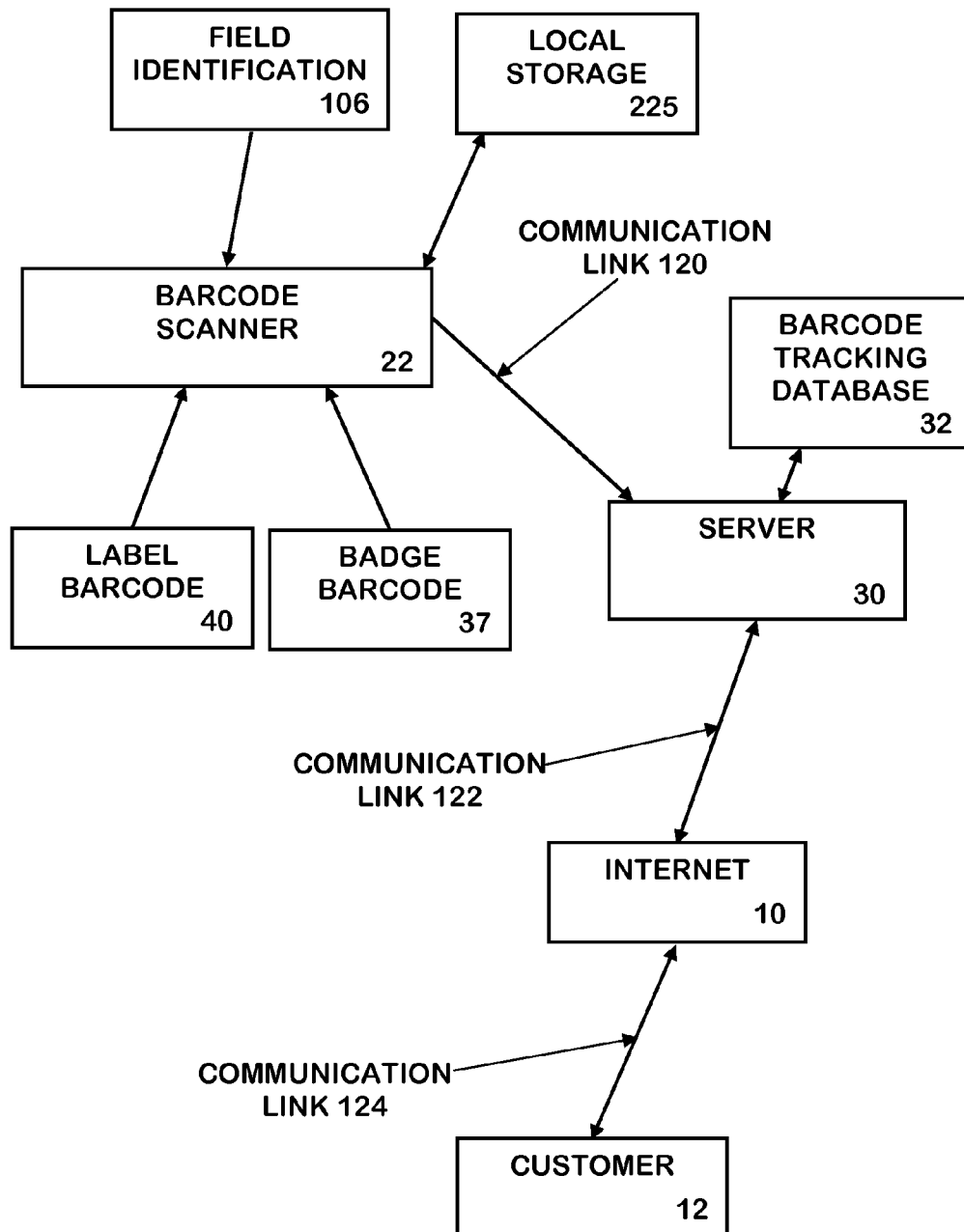

FIG. 8

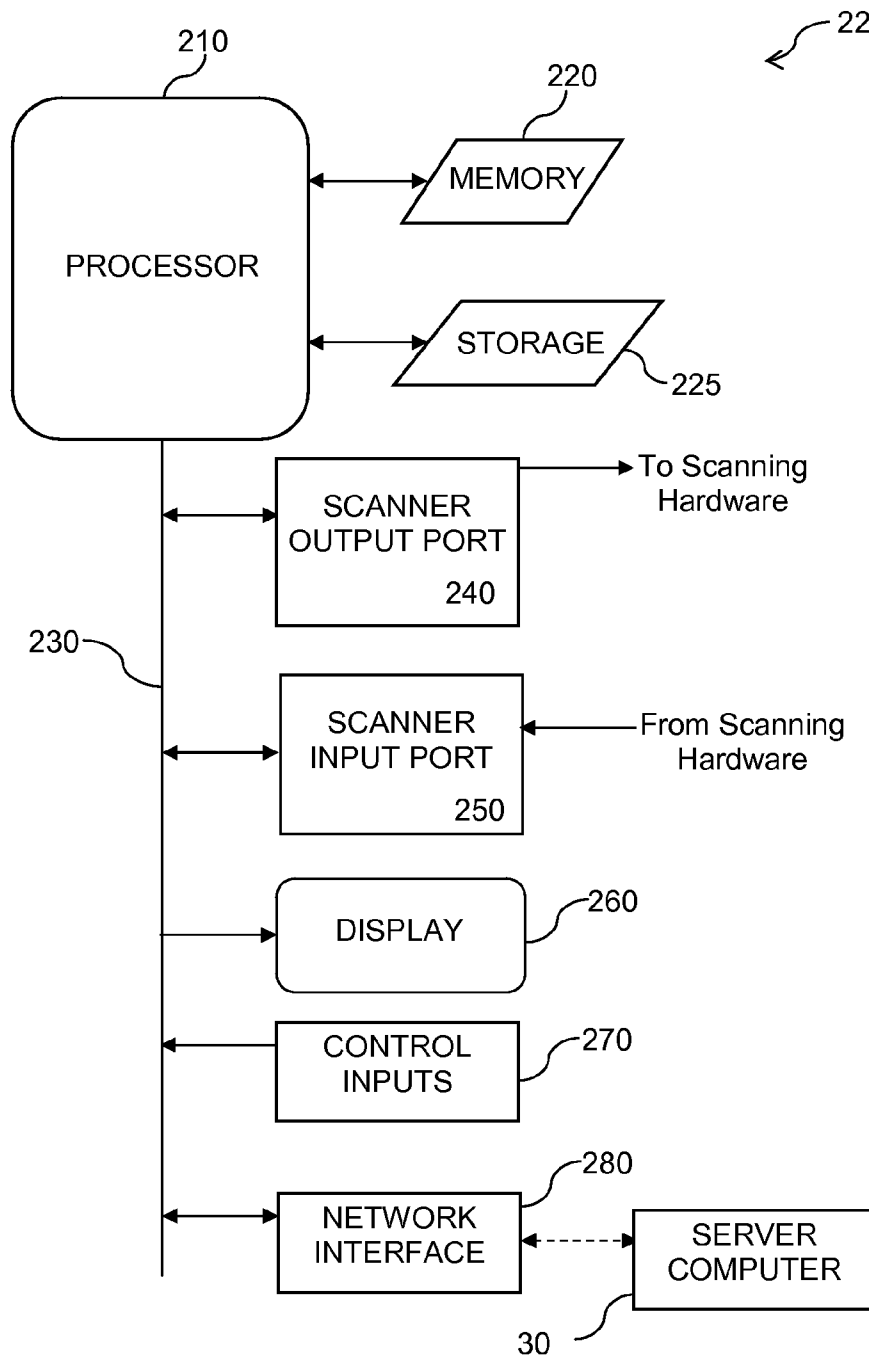

FIG. 9

1

SYSTEM AND METHOD FOR TRACKING ORIGINS OF PRODUCE

FIELD OF THE INVENTION

This invention relates to the field of tracking produce and more particularly to a system and method for tracking the origin of produce for health, safety and product feedback.

BACKGROUND OF THE INVENTION

The delivery of safe produce is performed by many farms in the United States and elsewhere. There have been incidences in which a small amount of produce was contaminated. For example, in 2007, an *E. coli* outbreak was reported and traced back to spinach. This contamination killed three people and sickened more than 200. Authorities isolated the *E. coli* strain and found that it originated from cattle feces and wild pig feces in river water used to irrigate the effected spinach farm. Since the outbreak, lawmakers in Congress have pushed for regular inspection of processing plants. Additionally, the FDA has announced voluntary guidelines for preventing food poisoning in fresh produce.

When such an outbreak occurs, produce from the entire farm is recalled, but often, only a portion of the produce is tainted. In the above example, all spinach from that farm and other farms was recalled and destroyed. There are many farms in which some fields are managed differently than other fields. For example, one field is irrigated with river water and another is irrigated with well water or water from a different source. Another example is one field having one set of pickers and another field having a different set of pickers. If one of the pickers contracts a contagious disease, there is no need to destroy crops from the fields that he or she didn't contact.

Similarly, once the produce is picked, it becomes indistinguishable from similar produce picked by other pickers on the same field or different fields. There is no way for the consumer or distributor/store to provide feedback to the growers regarding product quality, etc.

What is needed is a system and method for tracking produce back to individual fields and/or pickers.

SUMMARY OF THE INVENTION

In one embodiment, a system for tracking produce delivered to a consumer is disclosed including a field box and a plurality of containers that fit within the field box for holding the produce. A master label is affixed to the field box. The master label has a master label barcode and a plurality of sub-labels. The master label barcode has a sequence of digital values that uniquely differentiate each master label. Each sub label has a sub-label identifier that is related to or equivalent to the master label bar-code. The system also includes a server and a scanner. Software running on the scanner captures a value of the master label barcode and the origin of the produce then transfers (now or later) the value of the master label barcode and the origin of the produce to the server. Software running on the server receives the value of the master label barcode and the origin of the produce and stores them in a barcode tracking database for later access.

In another embodiment, a method for tracking produce delivered to a consumer is disclosed including providing a field box and a plurality of containers for holding produce, the containers fitting within the field box. A master label that has a master label barcode and a plurality of sub-labels is provided. The master label barcode has a sequence of digital values; the sequence of digital values uniquely distinguishes

2

each master label. Each sub label has a sub-label identifier related to or equivalent to the master label bar-code. The master label is affixed to the field box and each of the sub-labels from the master label is affixed to one of the containers.

5 The containers are then filled with produce and placed into the field box. The master label barcode is captured with a scanner and either now or at a later time, the captured master label barcode and the origin of the produce are transferred to a server where they are storing in a barcode tracking database.

10 In another embodiment, a method for tracking produce delivered to a consumer is disclosed including providing a field box and a plurality of clamshell containers that fit within the field box for holding the produce. A master label is provided that has a master label barcode and a plurality of sub-labels. Each sub label has a sub-label identifier that relates to the master label bar-code. The master label barcode has a sequence of digital values that uniquely distinguishes the master label. The master label is affixed to the field box and each of the sub-labels are peeled from the master label and affixed to each of the clamshell containers. Next, the clamshell containers are filled with produce then placed into the field box. Once full, the field box is delivered to a harvest manager where the harvest manager captures the master label barcode and an employee badge barcode from an employee badge with a scanner. The employee badge is associated with the produce picker. Now or at a later time, the captured master label barcode and the employee badge barcode is transferred to a server where they are received and stored in a barcode tracking database.

BRIEF DESCRIPTION OF THE DRAWINGS

The invention can be best understood by those having ordinary skill in the art by reference to the following detailed description when considered in conjunction with the accompanying drawings in which:

FIG. 1 illustrates a plan view of a label system of the present invention on a field box.

FIG. 2 illustrates a perspective view of a label system of the present invention in use.

FIG. 3 illustrates a perspective view of a system of the present invention.

FIG. 4 illustrates a schematic view of a system of the present invention.

FIG. 5 illustrates a first flow chart of the present invention.

FIG. 6 illustrates a second flow chart of the present invention.

FIG. 7 illustrates a typical user interface of the present invention.

FIG. 8 illustrates a directed chart of the present invention.

FIG. 9 illustrates a schematic view of a scanner of the present invention.

DETAILED DESCRIPTION OF THE INVENTION

Reference will now be made in detail to the presently preferred embodiments of the invention, examples of which are illustrated in the accompanying drawings. Throughout the following detailed description, the same reference numerals refer to the same elements in all figures.

Referring to FIG. 1, a plan view of a label system of the present invention on a field box is shown. The label **42** is affixed to a surface of the field box **33**. The label **42** has a barcode **40** that includes a sequence of digital values (for example, numbers). The label **42** also includes a plurality of sub-labels or child labels **44**, in this example eight sub-labels **44**. Any number of sub-labels **44** is possible, one for each

sub-container held within the over-box or field box **33**. Each sub-label **44** has a sub-label identifier that relates to the barcode **40**. In some embodiments, the sub-label identifier is a printed series of characters that relate to the sequence of digital values such as "5422187623." In some embodiments, the sub-label identifier includes a barcode that relates to the sequence of digital values. There is at least one sub-label **44** for each sub-container and, in some embodiments, one or more spare sub-labels **44** are provided in case one does not stick or is destroyed.

The field box **33** is a container that holds two or more sub-boxes or sub-containers. For example purposes, the term "clamshell" is used throughout this application to refer to the sub-boxes or sub-containers.

Referring to FIG. 2, a perspective view of a label system of the present invention in use is shown. Before or after filling the clamshell boxes **34** with produce, the sub-labels **44** are peeled from the master label **42** and, each sub-label **44** is affixed to each of the clamshell boxes **34** and the clamshell boxes **34** are placed in the field box **33**. Note that the barcode **40** on the master label **42** is the same as or related to the sub-label identifier (e.g., barcode **43** or printed digits) on each of the sub-labels **44**. In one embodiment, the barcode **40** on the master label **42** has the same numerical value as the sub-label identifier (e.g., barcode **43** or printed digits) on each of the sub-labels **44**. In alternate embodiments, some of the numerical values are the same and some differ to distinguish the individual sub-labels. In all embodiments, the barcode **40** is unique, in that, no two sets of labels have the same barcode so as to permit identification of the produce by the barcode.

Referring to FIG. 3, a perspective view of a system of the present invention is shown. In this example, the picker **38** delivers the field box **33** to a harvest manager or foreman **8** who uses a scanner **22** to scan the barcode **42**. In some embodiments, an employee badge barcode **37** on an employee badge **36** of the produce picker **38** is scanned to relate the barcode **40** of the produce to the employee badge barcode **37** (e.g., employ identification number) of the employee.

Any known scanner **22** is anticipated including, but not limited to, hand-held, self-contained portable scanners and tethered scanners, as known in the industry. In embodiments in which the scanner is portable, the data collected is either sent by wireless methods or stored internally to the scanner **22** and sent or transferred at a later time. In embodiments in which the scanner is tethered (connected to a fixed computer base), the data collected is either sent by wired methods, wireless methods or stored internally to the scanner **22** or its associated fixed computer base and sent or transferred at a later time.

Referring to FIG. 4, a schematic view of a system of the present invention is shown. When the field box **33** is distributed to the picker **38**, the barcode **40** on the label **42** and the barcode **37** on the picker's badge **36** are scanned by a portable scanner. In some embodiments, these barcodes **40/37** are stored and held at the scanner (field scanner) **22** until the scanner is connected to the server **30** for data capture **20**. There are many ways to connect the scanner(s) **22** to the server **30** including, but not limited to, a wireless connection (e.g., 802.11, IRDA, other IR link), a wired connection (e.g., USB, DB9 Serial Port) and a wired connection within a cradle (e.g., USB, Serial) whereas the cradle also provides power for charging the scanner **22**. In some embodiments, the server **30** is located remote to the scanners **22** and the data capture **22** is transmitted to the server **30** through a wide area network such as the internet **10**.

The uploaded data contains a data record for each field box. The data record contains at least the barcode **40** of the field box **33** and an identification of the origin (e.g., a specific plot, field, row, etc). In some embodiments, the identification of the origin is defined by the barcode **37** of the picker **38** since the picker is assigned to a specific field, plot, etc. In some embodiments, the origin emanates from a stored value in the scanner **22**. In some embodiments, the origin is keyed in or scanned into the scanner **22**. In addition, in some embodiments, the data record also includes the barcode of the picker **37**.

The uploaded data records are entered into a barcode tracking database **32** for future access and analysis. One use of the data records in the barcode tracking database **32** is to determine how many field boxes **33** were picked by a particular picker **38**. Another use of the data records in the barcode tracking database **32** is to determine the origin of a given field box **33** for tracing to origin and/or for providing feedback to the grower regarding customer feedback.

In some embodiments, the server **30** is networked to the Internet **10** (WWW) and one or more customers **12/14/16** have access to an application in which the customers **12/14/16** enter the barcode **40** from a purchased clamshell box **34** and provide feedback regarding the quality, freshness, taste, etc. The feedback is added to the barcode tracking database **32** and is then accessible to the owner/manager of the originating farm(s).

Referring to FIG. 5, a first flow chart of the present invention is shown. The tracking process begins with providing **50** a master label **42**. In some embodiments, the master label **42** is provided on a roll. The master label **42** has a plurality of sub-labels **44**. The barcode **40** on the master label **42** matches or relates to the sub-label identifier (e.g., barcode **43**) on each of the sub-labels **44** and, the barcode is unique, in that, no other master label has the same barcode (at least statistically or during the expected life of the barcode).

The tracking process continues with affixing **52** a master label **42** to each field box **33** as the field box **33** is built or remanufactured/cleaned. In the preferred embodiment, the master label **42** is a peel-and-stick label and peeled from a backing and affixed to the field box **33**, although other methods are well known in the industry, all of which are hereby included.

When the field box **33** is ready to be filled, the child stickers or sub-labels **44** are peeled off **54** and each one is affixed to a clamshell or sub-carton **34**. Although the term "clamshell" is used throughout this description for simplicity, any carton or container is possible. For example, for strawberries, clear plastic clamshells **34** are often used, but alternately, a one-pint or two-pint wooden or plastic basket is sometimes used. The present invention is intended for any produce that is distributed in a plurality of containers and a subset of the plurality of containers is shipped in an over box (or field box as described above).

Next, the picker fills the clamshells with produce **56**. In some embodiments, the picker fills the clamshells **34** with produce and later affixes the label, etc. The clamshells **34** are then loaded **58** into the field box **33**.

Once the field box is filled with clamshells **34**, the master label barcode **40** is scanned **60**. In the preferred embodiment, a barcode **37** from the picker's badge **36** is also scanned to correlate the produce in the clamshells **34**/field box **33** with the picker **38**. In some embodiments, the scanner **22** is pre-programmed with an identification of the origin of the produce (e.g., field, row, plot, etc.). In some embodiments, the location of the field is entered on the scanner **22** to indicate the origin of the produce (e.g., field, row, plot, etc.). In some

embodiments, the barcode from the picker's badge **37** is used to determine the origin of the produce (e.g., field, row, plot, etc.), being that the picker **38** is assigned to a particular field, row, plot, etc.

A data record is created **64** including the barcode **40** of from the label **42** and the origin of the produce. Preferably, the origin of the produce is determined from the badge barcode **37** and, therefore, the data record includes the badge barcode **37**. In some embodiments, the data record includes an identifier uniquely identifying the origin of the produce (field, row, plot, etc.).

At some time, one or more data records are uploaded **66** to the server **30** and the server **30** stores **68** the data record(s) in the barcode tracking database **32**.

Referring to FIG. **6**, a second flow chart of the present invention is shown. After a customer purchases the produce **70** and is either happy or unhappy with the produce **72**, they are now able to provide feedback directly to the farm, picker and/or manager down to the package or plot level. In one embodiment, there is a web address (e.g., <http://www.wish-farms.com>) printed on the sub-label **44**. The customer accesses the web address **74** and is presented with a user interface (such as that in FIG. **7**). The customer enters the sub-label identifier (e.g., barcode **43** or series of characters) of from the sub-label **44** on the produce **76** into the user interface **76** then provides their evaluation of the produce **78**. For example, the customer is unhappy because the produce is spoiled. Once the evaluation is completed by the customer, it is stored and available for delivery to the farm manager **80** or other person so that they can act upon the evaluation.

Referring to FIG. **7**, a typical user interface of the present invention is shown. In this sample user interface **90**, the customer enters contact information, including, in this example, their name, email address and phone number. In this example, the customer also indicates where they purchased the produce. The barcode **43** from the produce is entered in the appropriate fields and the customer has a field to enter a comment or simply check a box if their concern is covered by one of the bullet point **92**. The fields shown are examples of one possible user interface. Many alternate user interfaces are known and included in the present application.

Referring to FIG. **8**, a directed chart of the present invention is shown. The label barcode **40** is captured by the scanner **22**. In some embodiments, the badge barcode **37** is also captured by the scanner **22**. In some embodiments, a field identification **106** is either entered on the scanner's **22** user interface or stored within the scanner's **22** memory. In some embodiments, the data collected is stored in local storage **225** for later transmission. Once the data is captured or at some time in the future, a data record for each field box **33** is transferred to the server, preferably over a communications link **120**. In alternate embodiments, the data records are transferred by transferring a memory device such as a compact flash card or USB memory stick. The communications link **120** is any transmission link known in the industry, wired or wireless, such as 802.11, USB, Ethernet, Firewire, etc.

After the data records arrive at the server **30**, they are stored in the barcode tracking database **32** for access in providing customer feedback, for determining picker performance and/or for tracking the origin of produce back to the field, row, plot, etc. For customer feedback, the server **30** is connected to the Internet **10** by a communications link **122**. The communications link **122** is any transmission link known in the industry, wired or wireless, such as 802.11, USB, Ethernet, Firewire, etc. Likewise, the customer(s) is/are connected to the Internet by a communications link **124**. This communications link **124** is any transmission link known in the indus-

try, wired or wireless, such as 802.11, USB, Ethernet, Firewire, DOCSIS, Cable, FIOS, DSL, etc.

Referring now to FIG. **9**, a schematic view of a barcode scanner of all embodiments of the present invention is shown. The barcode scanner **22** is shown for completeness and the device shown is a simplified example of a typical processor-based scanner that has a processor **210** and associated memory **220** and storage **225**. The storage is, for example, Flash memory, battery-backed SRAM or a hard disk. This is an exemplary system and any suitable processor, memory and persistent storage can be substituted including microcontrollers such as the Intel® 80C51, processors such as the Intel® Pentium IV, memory such as SDRAM and DDR and persistent storage such as ROM, EPROM, hard disks, etc. The operating program, data parameters and scanned barcode containing records are typically stored in the persistent storage **225**. A system bus **230** interfaces the processor to peripheral devices as discussed below.

The scanner **22** displays information, alerts, prompts, etc., on a display **260**. In some embodiments, the display **260** is a graphics display. In some embodiments, the display **260** is a LCD display. In other embodiments, the display is a numeric display, alpha-numeric display, set of lights or any combination thereof. Operation of the system is initiated by control inputs **270**. In some embodiments, the control inputs **270** include a keyboard. In other embodiments, the control **270** includes push buttons, switches, potentiometers and digital potentiometers, etc.

The scanner **22** controls the optical scanning hardware through a scanner control output port **240** as known in the industry. There are many known barcode scanning technologies, usually employing a lasing LED to illuminate the barcode while a detector measures reflected light to determine the digits of the barcode. All known barcode technologies including, but not limited to, linear barcodes, two-dimensional barcodes, matrix barcodes, two-dimensional stacked barcodes, postal barcodes, postnet postal barcodes and onecode postal barcodes are included, here within. Likewise, all known encodings of barcodes are also included here within.

Outputs from the scanning hardware are fed to the scanner processor **210** through a scanner input port **250**.

The scanner interfaces to the server computer **30** through a network interface **280** connected to the system bus **230**. In some embodiments, the part or all of the storage **225** is removable (e.g. SD, memory stick or Compact Flash) and the data records are transferred on the removable storage to the server computer **30**.

Equivalent elements can be substituted for the ones set forth above such that they perform in substantially the same manner in substantially the same way for achieving substantially the same result.

It is believed that the system and method of the present invention and many of its attendant advantages will be understood by the foregoing description. It is also believed that it will be apparent that various changes may be made in the form, construction and arrangement of the components thereof without departing from the scope and spirit of the invention or without sacrificing all of its material advantages. The form herein before described being merely exemplary and explanatory embodiment thereof. It is the intention of the following claims to encompass and include such changes.

What is claimed is:

1. A system for tracking produce delivered to a consumer, the system comprising:
 - a field box;

7

a plurality of containers for holding the produce, the containers fitting within the field box for shipment and the containers being within which the consumer will eventually obtain the produce;

a pre-printed master label affixed to the field box, the pre-printed master label having a master label barcode and the pre-printed master label having a plurality of sub-labels, each sub label having a sub-label identifier, the sub-label identifier being related to the master label bar-code, the master label barcode having a sequence of digital values, the sequence of digital values uniquely distinguishing the pre-printed master label;

a server;

a scanner;

software running on the scanner for capturing a value of the master label barcode and a produce origin;

software running on the scanner for transferring the value of the master label barcode and the produce origin to the server; and

software running on the server for receiving the value of the master label barcode and the produce origin and software running on the server for storing the value of the master label barcode and the produce origin in a barcode tracking database.

2. The system for tracking produce delivered to a consumer of claim 1, wherein the sub-label identifier includes the sequence of digital values.

3. The system for tracking produce delivered to a consumer of claim 1, wherein the sub-label identifier includes the sequence of digital values along with additional digital values uniquely identifying each of the sub-label identifier.

4. The system for tracking produce delivered to a consumer of claim 1, further comprising an employee badge associated with a produce picker, the employee badge having an employee badge barcode; wherein the employee badge barcode is scanned and associated with the master label barcode.

5. The system for tracking produce delivered to a consumer of claim 4, wherein the produce origin is determined based upon the employee badge barcode.

6. The system for tracking produce delivered to a consumer of claim 1, wherein the produce origin is determined based upon a parameter stored in the scanner.

7. The system for tracking produce delivered to a consumer of claim 1, wherein the produce origin is scanned and stored in the scanner.

8. The system for tracking produce delivered to a consumer of claim 1, wherein the pre-printed master label has a sticky backing and is affixed to the field box.

9. The system for tracking produce delivered to a consumer of claim 8, wherein the sub-labels are peel-and-stick labels removably affixed to the master label and the sub-labels are peeled from the pre-printed master label and affixed to the containers.

10. A method for tracking produce delivered to a consumer, the method comprising:

providing a field box;

providing a plurality of containers for holding the produce, the containers fitting within the field box and the containers being within which the consumer will eventually obtain the produce;

providing a pre-printed master label, the pre-printed master label having a master label barcode and the pre-printed master label having a plurality of sub-labels, each sub label having a sub-label identifier, the sub-label identifier being related to the master label bar-code, the master

8

label barcode having a sequence of digital values, the sequence of digital values uniquely distinguishing the pre-printed master label;

affixing the pre-printed master label to the field box;

peeling each of the sub-labels from the pre-printed master label and affixing each of the sub-labels to one of the containers;

filling the containers with the produce;

placing the containers into the field box;

capturing the master label barcode with a scanner;

transferring the captured master label barcode and a produce origin to a server; and

receiving the captured master label barcode and the produce origin at the server and storing the captured master label barcode and the produce origin in a barcode tracking database.

11. The method for tracking produce delivered to a consumer of claim 10, wherein the sub-label identifier includes the sequence of digital values.

12. The method for tracking produce delivered to a consumer of claim 10, wherein the sub-label identifier includes the sequence of digital values along with additional digital values uniquely identifying each sub-label.

13. The method for tracking produce delivered to a consumer of claim 10, further comprising:

scanning an employee badge barcode with the scanner from an employee badge associated with a produce picker; and

associating the employee badge barcode with the master label barcode.

14. The method for tracking produce delivered to a consumer of claim 13, wherein the produce origin is determined based upon the employee badge barcode.

15. The method for tracking produce delivered to a consumer of claim 10, wherein the produce origin is determined based upon a parameter stored in the scanner.

16. The method for tracking produce delivered to a consumer of claim 10, further comprising:

scanning the produce origin into the scanner.

17. The method for tracking produce delivered to a consumer of claim 10, further comprising:

accessing a feedback application through the internet;

entering the sub-label identifier into the feedback application; and

entering feedback data into the feedback application regarding the produce.

18. The method for tracking produce delivered to a consumer of claim 10, further comprising:

accessing the captured master label barcode and the produce origin from barcode tracking database to determine the origin of produce, the produce having a health risk associated therewith.

19. A method for tracking produce delivered to a consumer, the method comprising:

providing a field box;

providing a plurality of clamshell containers for holding the produce, the clamshell containers fitting within the field box and the clamshell containers being within which the consumer will eventually obtain the produce;

providing a pre-printed master label, the pre-printed master label having a master label barcode and the pre-printed master label having a plurality of sub-labels, each sub label having a sub-label identifier, the sub-label identifier being related to the master label bar-code, the master label barcode having a sequence of digital values, the sequence of digital values uniquely distinguishing the pre-printed master label;

9

affixing the pre-printed master label to the field box;
peeling each of the sub-labels from the pre-printed master
label and affixing each of the sub-labels to one of the
clamshell containers;
filling the clamshell containers with the produce;
placing the clamshell containers into the field box;
delivering the field box to a harvest manager;
capturing the master label barcode with a scanner;
capturing an employee badge barcode from an employee
badge with the scanner, the employee badge associated
with a produce picker;
transferring the captured master label barcode and the
employee badge barcode to a server; and

10

receiving the captured master label barcode and the
employee badge barcode at the server and storing the
captured master label barcode and the employee badge
barcode in a barcode tracking database.
5 **20.** The method for tracking produce delivered to a con-
sumer of claim **19**, further comprising:
storing a produce origin in the scanner; and
transferring the produce origin along with the captured
master label barcode and the employee badge barcode to
the server.

* * * * *